

く た ず
組み立て図

よろよろ動^{うご}くモデル

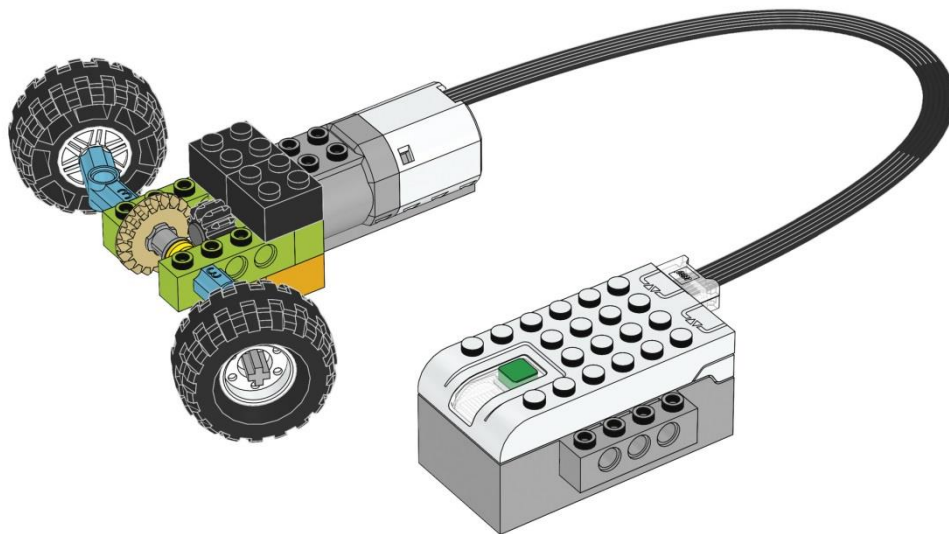

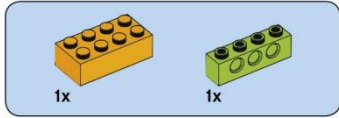

1

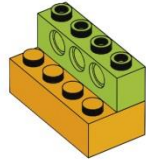



2

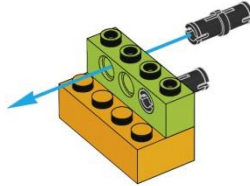

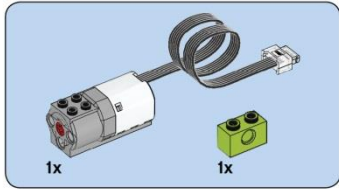

3

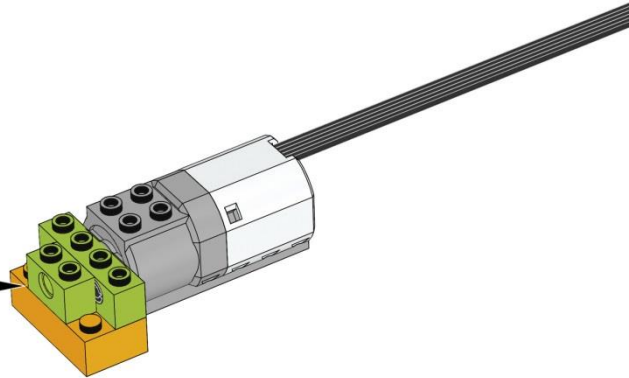

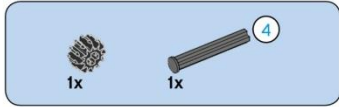

4

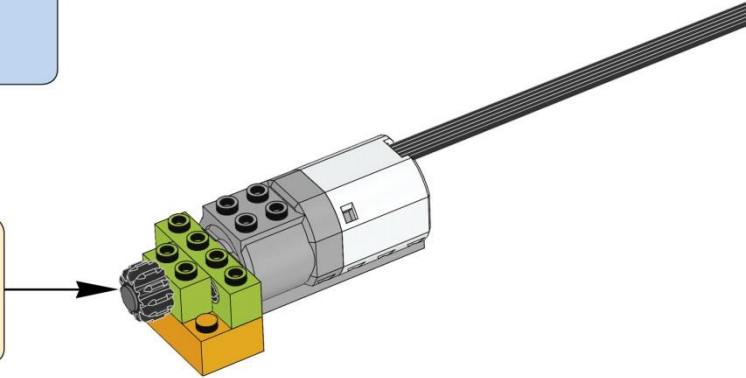
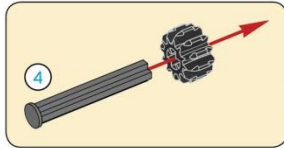

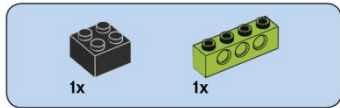

5

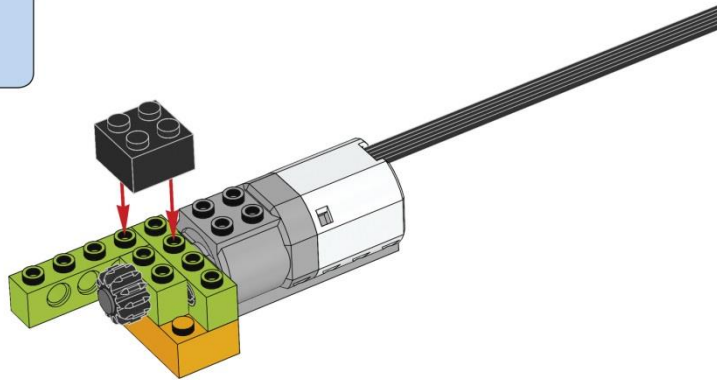

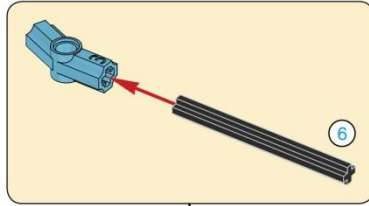
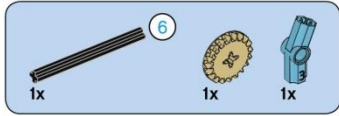

6

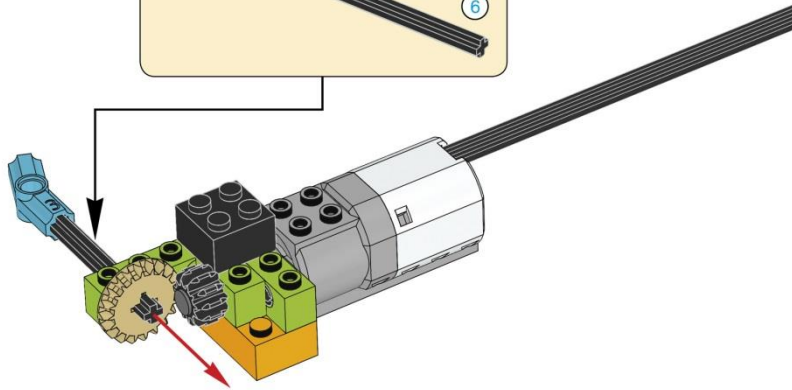



7

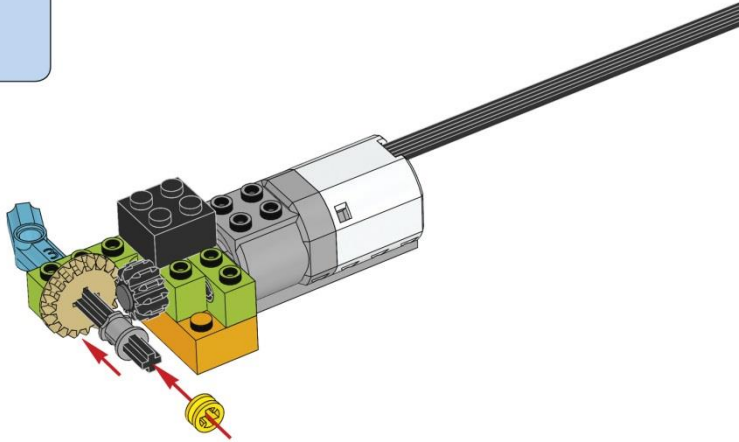

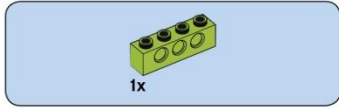

8

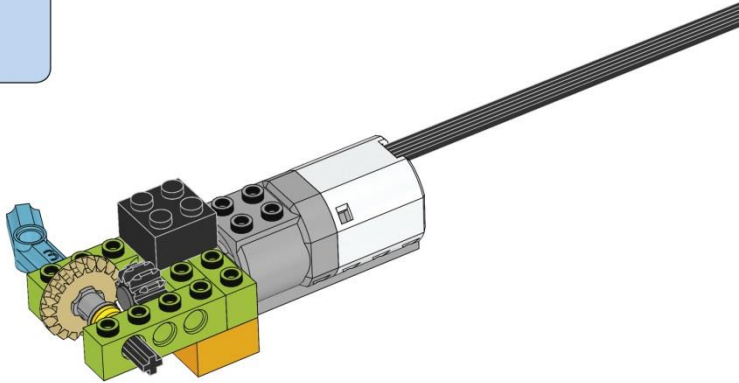

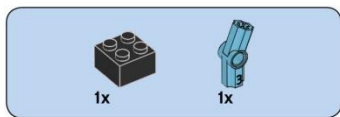

9

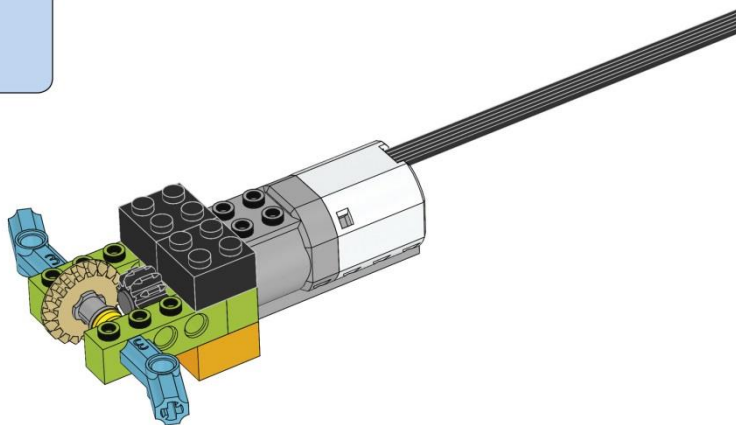

みづいろ と つ む たいせつ
水色のパーツは、取り付ける向きが大切だよ。

すうじ む ちゅうい
パーツについている「3」の数字の向きに注意してね。

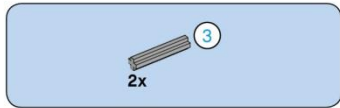

10

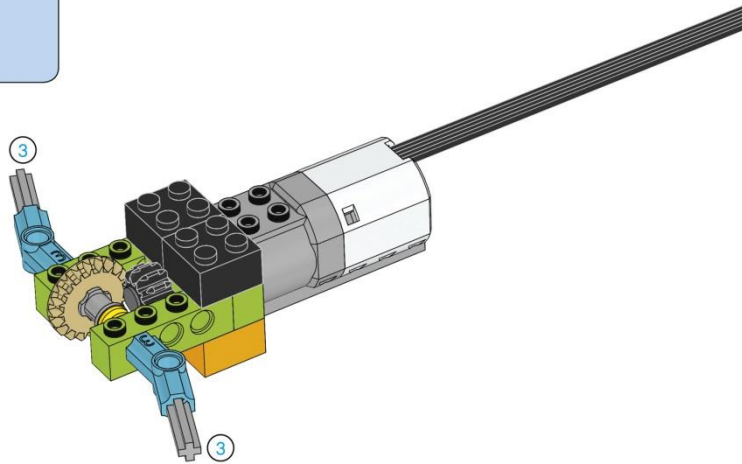

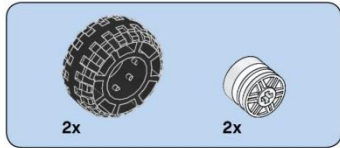

11

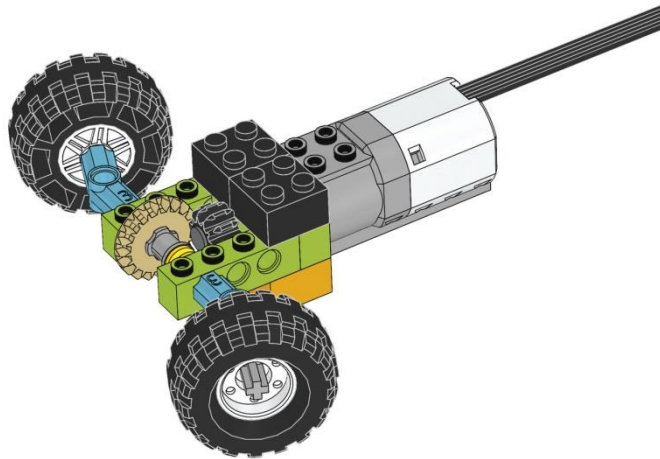

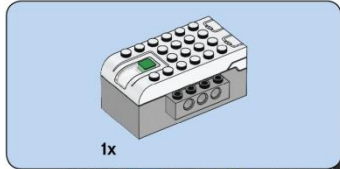

12

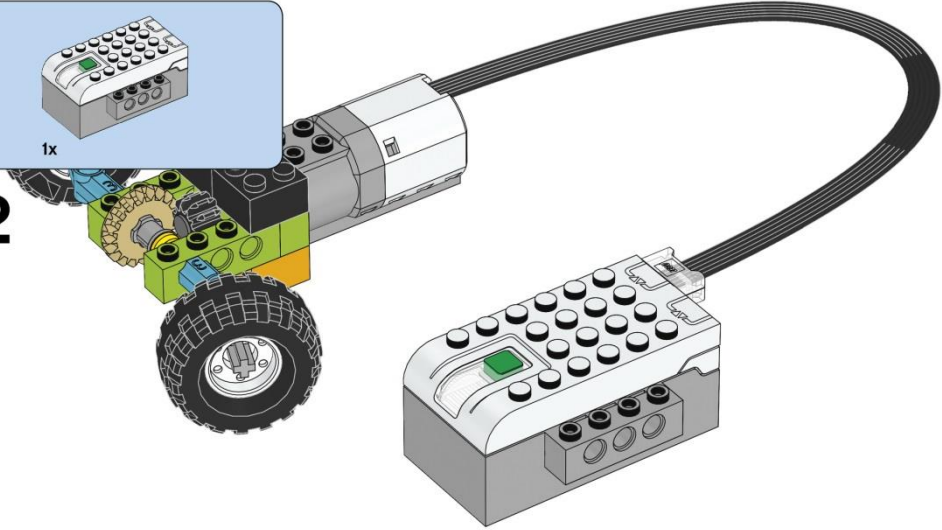

13

